



Bevelling system B15 AIR (B15 AIR-S)

Maximum bevel width 15 mm / 0.6 in. Edge rounding function.

B15 Air



Low RPM version
B15 Air-S
for Stainless

Powerful 2984 W pneumatic motor

Heavy-duty design

Machining depth
adjustment



Art. Nr. 27220 (B15 AIR)
Art. Nr. 27220S (B15 AIR-S)



HEAVY-DUTY





Designed for beveling and deburring of straight and shaped parts, internal and external radiuses and holes. Specially designed for producing visual bevels and welding preparation. Powerful pneumatic drive for extreme loads.

- Scale for an accurate bevel size adjustment
- For beveling and deburring of steel, aluminum and other materials
- Replaceable head for changing bevel angle
- Powerful handheld equipment
- Also suitable for explosion-risk operations
- Edge rounding function, preparation before surface treatment
- Low RPM model for processing of stainless steel
- Packed in a cardboard box

Technical data:

| | |
|---------------------|--|
| Bevel angle: | Replaceable head 30°, 37,5°, 45°, 50°, 60°- other angles on demand |
| Bevel width: | 0 to 15 mm / 0 to 0.6 in < 400 MPa / 58 015 PSI 0 to 8 mm / 0 to 0.31 in > 400 MPa / 58 015 PSI |
| Engine: | Pneumatic |
| Engine Power: | 2984 W |
| Speed: | 6000 rpm (B15 AIR-S 4200 rpm) |
| Air consumption: | 750 l/min |
| Operating pressure: | 6 bar / 87.02 PSI |
| Weight: | 7,5 kg / 16.5 lb |

Included in price:

B15 AIR beveling and deburring system (without the head).
Tools for an operator.
User manual.

| Machine name: | Art. Nr. |
|---|----------|
| Beveling and deburring system B15 AIR | 27220 |
| Beveling and deburring system B15 AIR-S | 27220S |





















| Accessories: | |
|--|---|
| Milling heads | see page 14-15 |
| Xpipe Beveler (Beveler B15 Air is not included) | see page 18-19 (and price advantage sets page 20-21) |
| Grinding adapter Edge Cleaner | see page 14 |
| Pneumatic set with quick couplings (contains: FRL - filtration, regulator and lubrication unit, quick couplings, hoses 10 m) | Art. Nr. 27221 |
| Special lubricating paste for the milling heads. Prevents seizing up, wear, cold-welding, solidifying of the threads 120g. | Art. Nr. 33005 |
| Universal tube key (for milling head´s removing) | Art. Nr. 25300.27 |



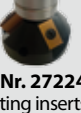

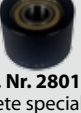
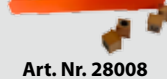
The Premium milling heads for processing tougher materials.

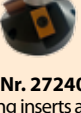
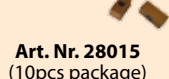
- For B10 Electra, B15 Electra and B15 AIR hand held bevelers
- Developed especially for stainless steel and other tougher materials
- More effective increased safety
- Smoother final surface and higher lifetime for the cutting inserts
- Longer cutting inserts (15 mm/0.6") are standard and two-sided
- Shorter cutting inserts (8 mm/0.3") are four-sided » double lifetime

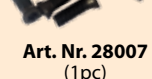
| Required bevel angle | The starter kit Premium milling head max 15 mm/0.6" two sided cutting inserts | The spare two sided cutting inserts 15 mm/0.6" | The additional special roller for shorter cutting inserts 8 mm/0.3" (the milling head stays original) | The shorter four sided cutting inserts 8 mm/0.3" | The fastening screws for the cutting inserts (works with both cutting inserts versions) |
|-------------------------------|---|---|--|---|---|
| 30° |  Art. Nr. 27223X (the cutting inserts and the lead roller Ø 30 mm / 1.19" are included) |  Art. Nr. 28015 (10pcs package) |  Art. Nr. 28004 (complete special lead roller Ø 33,5 mm / 1.32" for shorter cutting inserts) |  Art. Nr. 28008 (10pcs package) |  Art. Nr. 28007 (1pc) |
| 37.5° |  Art. Nr. 27227X (the cutting inserts and the lead roller Ø 26 mm / 1.02" are included) |  Art. Nr. 28015 (10pcs package) |  Art. Nr. 28013 (complete special lead roller Ø 30,5 mm / 1.2" for shorter cutting inserts) |  Art. Nr. 28008 (10pcs package) |  Art. Nr. 28007 (1pc) |
| 45° |  Art. Nr. 27222X (the cutting inserts and the lead roller Ø 26 mm / 1.02" are included) |  Art. Nr. 28015 (10pcs package) |  Art. Nr. 28005 (complete special lead roller Ø 31 mm / 1.23" for shorter cutting inserts) |  Art. Nr. 28008 (10pcs package) |  Art. Nr. 28007 (1pc) |
| 50° |  Art. Nr. 27224X (the cutting inserts and the lead roller Ø 26 mm / 1.02" are included) |  Art. Nr. 28015 (10pcs package) |  Art. Nr. 28014 (complete special lead roller Ø 31,5 mm / 1.24" for shorter cutting inserts) |  Art. Nr. 28008 (10pcs package) |  Art. Nr. 28007 (1pc) |
| 60° |  Art. Nr. 27240X (the cutting inserts and the lead roller Ø 19 mm / 0.75" are included) |  Art. Nr. 28015 (10pcs package) |  Art. Nr. 28006 (complete special lead roller Ø 25,5 mm / 1.01" for shorter cutting inserts) |  Art. Nr. 28008 (10pcs package) |  Art. Nr. 28007 (1pc) |
| Other angles on demand | | | | | |

Edge Cleaner - grinding adapter









| Edge Cleaner - grinding adapter (including 10pcs grinding rings grain 40, 1pc guiding roller) | Grinding rings, grain 40 (pack 50pcs) | Spare polyurethane guiding roller |
|--|--|--|
|  Art. Nr. 25310 |  Art. Nr. 25312 |  Art. Nr. 25311 |

Milling Heads and other accessories for B10 Electra, B15 Electra and B15 Air



The Rounding milling heads

- For B10 Electra, B15 Electra and B15 AIR hand held bevelers
- Smoother final surface and higher lifetime for the cutting inserts
- For edge rounding application

| Required radius | Complete radius milling head, including of the guiding roll and fastening screw | Radius 4 - sided cutting inserts | The fastening screws for the cutting inserts |
|--------------------|---|---|--|
| R 2.5 mm / 0.08 in |  Art. Nr. 27234X (the cutting inserts and the lead roller Ø 37 mm / 1.46" are included) |  Art. Nr. 26109 (10pcs package) |  Art. Nr. 28007 (1pc) |
| R 3.5 mm / 0.12 in |  Art. Nr. 27233X (the cutting inserts and the lead roller Ø 37 mm / 1.46" are included) |  Art. Nr. 26110 (10pcs package) |  Art. Nr. 28007 (1pc) |
| R 4 mm / 0.16 in | Compatible with the milling head R 3.5 mm / 0.12" Art. Nr. 27233X |  Part no. 26111 (10pcs package) |  Part no. 28007 (1pc) |

The older ECO milling heads. Available while supplied last.

| | Art. Nr. |
|---|----------|
| 30° cutting head (including inserts, screws, bolts and roller). Guide roller diameter Ø 34 mm / 1.34 in | 27223 |
| 50° cutting head (including inserts, screws, bolts and roller). Guide roller diameter Ø 28 mm / 1.10 in | 27224 |
| Coated cutting inserts - four-sided (pack of 10 pcs) | 27231 |
| Screw for the inserts | 27241 |

Lubricating paste

| | Art. Nr. |
|--|----------|
| Special lubricating paste for the milling heads. Prevents seizing up, wear, cold-welding, solidifying of the threads 120g. | 33005 |
| Universal tube key (for milling head's removing) | 25300_27 |
| Magnetic sweeper Mag Brush | 18654 |



Art. Nr. 27223



Art. Nr. 27231



Thousands of satisfied customers throughout the world



Xpipe Beveler (accessory for B-Line Machines)
Maximum bevel width 15 mm / 0.6 in. (10mm / 0.4 in.)
Edge rounding function.

Xpipe Beveler

Compatible with B10 Electra, B15 Electra and B15 Air

Ergonomic, rotating handle
increases work productivity

The bevel depth can be set
continuously

Lightweight aluminum construction
of the machine frame

Special one-way bearings for the roller
shutters prevent any kickback

The Beveling Machine
is not included with
Xpipe Beveler

Art. Nr. 25500



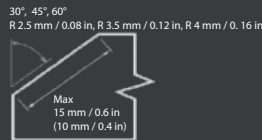

Bevelling tool for easy and fast machining of pipes from Ø 85 mm (3.36").
The maximum diameter of the pipe is not limited, and the tool can be used on flat materials.
The unique mechanism of clamping, guiding rollers ensures precise and comfortable guiding around the circumference of the machined pipe or along the edge of the sheet metal.
The robust frame of the body guarantees constant cut with a minimum of possible vibrations and uncompromising stability of the selected bevel angle.

- Designed to work with B10 Electra, B15 Electra and B15 AIR bevelling machine
- Continuous bevel depth settings built-in scale
- Special one-way bearings preventing kickback of approaching material, safe and comfortable beveling
- The set removal value can be ensured, and a constant chamfer depth can be guaranteed even on a larger number of pipes
- Unique, flexible mounting of the running rollers, suitable for any unevenness and inaccuracies around the circumference of the pipe
- Lightweight aluminum construction of the machine frame guarantees comfortable handling of the product
- Ergonomic, rotating handle for productivity and safety
- Safety cover for flying chips, preventing possible injuries
- Packed in a plastic box

Technical data:

| | |
|-------------------------------------|--|
| Bevel angle: | 30°, 45° and 60° |
| Bevel width: | 10 mm / 0.39" (with B10 Electra) 15 mm / 0.60" (with B15 Electra and B15 AIR) |
| Rounding app: | R 2,5 mm / R 0.10", R 3,5 mm / R 0.137", R4 mm / R 0.157" |
| Minimum ID (outside machining): | > Ø 85 mm / 3.36" |
| Wall thickness (outside machining): | 2,5 - 15 mm / 0.10" - 0.60" |
| Minimum ID (inside machining): | > Ø 500 mm / 19.7" (smaller Ø on request) |
| Wall thickness (inside machining): | 5 - 15 mm / 0.20" - 0.60" |
| Minimum clamping depth: | 80 mm / 3.15" |
| Thickness working (flat bevelling): | 3 - 20 mm / 0.11" - 0.78" |
| Feeding: | manual |
| Weight (without the machine): | 8,4 kg/18.5 lb. |

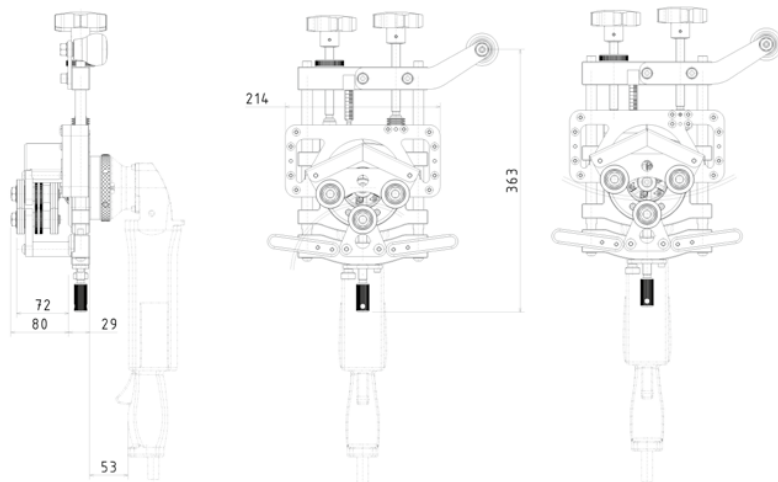

Included in price:

- Xpipe Beveler (without bevelling machine)
- Tools for an operator
- User manual

Cost effective sets, see page 20-21

Machine name:

The Xpipe Beveler (without bevelling machine)

Art. Nr.

25500





B-Line sets!

Compactible accessories for B10 Electra, B15 Electra and B15 Air





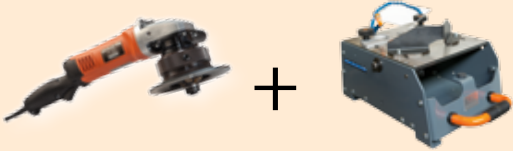

Cost effective accessories sets for B10 Electra, B15 Electra and B15 Air.





These accessories will transform your B-line into a versatile tool, which can handle most of your future projects.

You can bevel flat steel, or tubes, small workpieces or you can do rounding of the plate edges. All in one solution!

| <i>B10 Electra sets</i> | Set 230V | Set 120V |
|---|-----------------|-----------------|
|  <p>B10 Electra B-Dock</p> | Art. Nr. 25302 | Art. Nr. 25303 |
|  <p>B10 Electra Xpipe Beveler</p> | Art. Nr. 25304 | Art. Nr. 25306 |
|  <p>B10 Electra B-Dock Xpipe Beveler</p> | Art. Nr. 25305 | Art. Nr. 25307 |



| B15 Electra sets | | Set 230V | Set 120V |
|---|--|-----------------|-----------------|
|  +  B15 Electra B-Dock | | Art. Nr. 25252 | Art. Nr. 25253 |
|  +  B15 Electra Xpipe Beveler | | Art. Nr. 25254 | Art. Nr. 25256 |
|  +  +  B15 Electra B-Dock Xpipe Beveler | | Art. Nr. 25255 | Art. Nr. 25257 |

| B15 Air sets | | Pneumatic powered |
|---|--|--------------------------|
|  +  B15 Air Xpipe Beveler | | Art. Nr. 27225 |
|  +  B15 Air - S Xpipe Beveler | | Art. Nr. 27225S |